

# PoolCo USA

## Construction Supplies

Product No.	Description	Price
<b>Vermiculite-Premium South African Grade with Easy Trowel Additives</b>		
PX55	A-Tops Pre-mix- 2 Cubic Ft.- 50 Bags per skid - Regular & Pump Mix	24.00
PB42	A-Tops Regular Vermiculite- 4 Cubic Ft (plastic bag) 27 bags per skid	24.50
	½ and Full Truck load Drop-ships available, call for quote.	
<b>Approximate Coverage Chart for In-ground Pools</b>		
	<i>Size</i>	<i>A-Tops</i>
	16 x 32	60
	18 x 36	75
	20 x 40	95
		<i>Regular</i>
		32
		41
		50
These figures are approximate and based on 2" thickness. Our experience demonstrates that you can get by with less. The amount of vermiculite may vary with the amount of water, mixing time, accuracy of excavation and troweling practice. Be sure to fill dips and low areas with other material so mix is not wasted unnecessarily.		
<b>Flex Piping</b>		
PF50	½" PVC Flex Pipe – 100 ft. Roll	100.00
PF75	¾" PVC Flex Pipe - 100 ft. Roll	122.00
PF10	1" PVC Flex Pipe - 100 ft. Roll	136.00
PF15	1 ½" PVC Flex Pipe - 50 ft. Roll	92.00
PF15-100	1 ½" PVC Flex Pipe - 100 ft. Roll	182.00
PVC15	1 ½" PVC Rigid - 10' Piece	8.00
PF20	2" PVC Flex pipe - 50 ft. Roll	138.00
<b>Sealants &amp; Adhesives &amp; Misc.</b>		
--	1 ½" x 100' Black Poly-Pipe 100 psi NSF Rated	130.00
BSA	Spray Tack Glue - For foam installation	19.00
Blue72	3-M Premium Spray Tack Glue- For foam installation	23.00
0530318	Epoxy Putty Sticks 2-part 7oz.	16.00
0530339	2-part Epoxy Pool Paste	8.00
PLA6	Plast-Aid - 6oz. fast set repair kit	40.00
BB260	Teflon Tape - ½" x 520"	.75
DT60P	Premium Duct Tape - Special for vinyl pools, 2" x 60 yds.	12.00
828	Premium all Stainless Steel Clamps – fits 1 ½" & 2" pipe	1.50
828-10	Premium all Stainless Steel Clamps – fits 1 ½" & 2" pipe (10-box price)	Each - 1.20
<b>Wall Foam</b>		
WF125-2	2lb. Wall Foam - 1/8" x 42" x 125' - Standard	68.00
WF125-3	3lb. Wall Foam - 1/8" x 42" x 125' - Standard	84.00
F250-25	¼" Foam - ¼" x 48" x 250'	300.00
<b>Pool Cove</b>		
PC4	Pool Cove - Peel N' Stick	9.00
PC4-48	Pool Cove Case- Peel N' Stick, 48 pieces	310.00

### Pool Cove Chart

	Qty. Required	Pool Size	Qty. Required
15' Round	12	30' Round	25
18' Round	15	15' x 30' Oval	
			Pool Size
21' Round	17	16' x 32' Oval	20
24' Round	19	18' x 33' Oval	22
27' Round	22	18' x 36' Oval	24

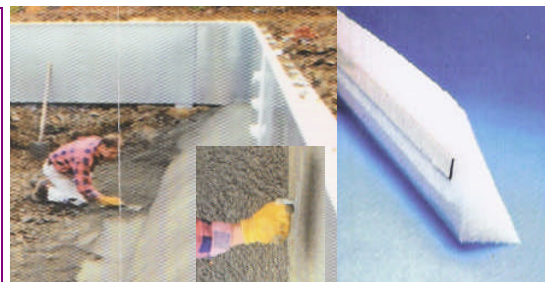

# PoolCo USA

## MORTEX

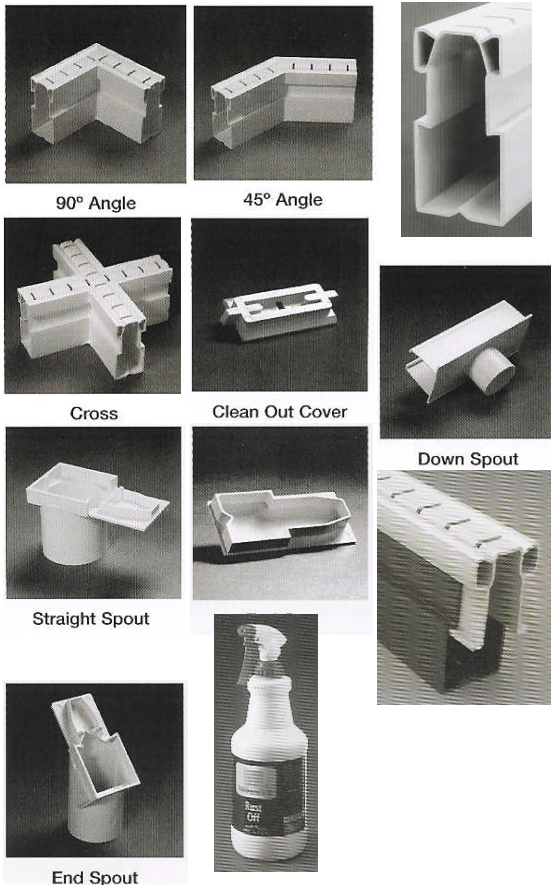

<b>Systemx</b>		
<b>Part No.</b>	<b>Description</b>	<b>Price</b>
PSB	Systex Bonder- 5 gal bucket	350.00
PST	Systex Texture- 50 lb. bags	90.00
PSCTN	Systex Color- Tan	310.00
PSCGY	Systex Color- Gray	310.00
PSCAD	Systex Color- Almond	310.00
PSCPH	Systex Color- Peach	310.00
PSCCY	Systex Color- Clay	310.00

<b>Control Joints</b>		
CJW	Control Joint - White- 396' Box	345.00
CJRTW	Control Joint Replacement Top-White200'	150.00
CXC96SLT	Fill-N-Flex Tan Self Leveling joint Seal	190.00

<b>Drain Rite</b>		
DRW	Drain Rite- White- 100' Case	460.00
DRG	Drain Rite- Gray- 100' Case	470.00
DRT	Drain Rite- Tan- 100' Case	470.00
DRC	Drain Rite- Charcoal- 100' Case	470.00
DX90W	90 Degree Angle- White	13.00
DX45W	45 Degree Angle- White	13.00
DXXW	Cross- White	24.00
DXTW	Tee- White	19.00
DXCOCW	Clean Out Cover- White	3.00
DXDS	Down Spout- White	9.00
DXSSW	Straight Spout- White	9.00
DXECW	End Cap- White	3.00
DXESW	End Spout- White	9.00
DXRTW	Drain Rite Replacement Top- White- 80'	240.00
DXRTG	Drain Rite Replacement Top- Gray- 80'	250.00
DRW-1	Drain Rite- 10' Section Drain- Each	48.00

<b>Accessories</b>		
FKLAK	Aluminum Key-Lock Keystone forms+Key	690.00
FXARC	Aluminum 112 AWM Keylock Radius Cut	620.00
FXARKS	Aluminum Keylock Radius Cut - Per Foot	44.50
FFGK	Fiberglass Forms	360.00
FKF	Plastic Keystone Forms Only	330.00
FXRCR	Plastic Keylock Radius Cut Retainer-PerFt	3.00

# PoolCo USA

## Safety equipment & deck Accessories

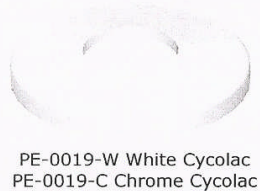

Part No.	Description	Price
<b>Anchors:</b>		
PS-4016-C	4" Brass Anchor (available also in 20" channel)	29.00
PS-4019-C	4" Aluminum Hanover Clone(Wedge #PW-4C)(for 1.9)	11.00
PC-4008-AC	8"Channel Set w/4" Aluminum Hanover Clone (for 1.9)	34.00
PC-4020-AC	20" Channel Set w/4" Alum. Hanover Clone (for 1.9")	36.00
07661	4" Glass filled PP ( Plastic anchor f/salt water solutions)	14.00
HEBA	Chrome/ Brass Anchor- for vinyl/fiberglass	12.00
JH	Johnny Hinge	240.00
<b>Pool Bond:</b>		
PB-2008	Cast Bronze International Electrical Bond	22.00
<b>Escutcheon:</b>		
PE-0019-C	Chrome Plated Cycolac	6.00
PE-0019-W or G	White or Grey Cycolac	2.80
PE-0019S	Stainless Steel Round	7.00
25572-202	Split Clip-on Rail - Chrome Plated	20.00
25572-200	Split Clip-on Rail - White	14.00
<b>Perma- Flange:</b>		
PF-3119	Aluminum White Slide Flange	16.00
PF25	Cycolac Slide Flange	17.00
PF25-A	Cycolac Slide Flange with mounting hardware	24.00
PF2115-L	Ladder Flange for 1.5" tube	10.00
8700	White ABS Plastic Ladder Flange A/G	4.00
<b>Perma- Hook: Chrome Plated Brass</b>		
PH-51H	Loop Hook (3/4 inch) (special order only)	24.00
PH-53	Cleat Type Hook (3/4 inch)	17.00
PH-55	S Hook (Chrome Plated Brass)	5.00
<b>Perma- Eye: Chrome Plated Brass</b>		
PI-72	Removable eye for Vinyl (not shown)	16.00
PI-70	Oval Rope Eye- coping mount (Pair)	12.00
PI-72B	Removable Eye for Vinyl Liners (QP Type) (Single)	16.00
PI-2000	Removable Eye for Vinyl Liners	18.00
PI-74S	Special Rope Eyes with Lag Shield	20.00

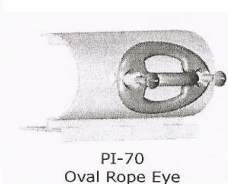

# PoolCo USA

## Salt System Corrosion Prevention



Part No.	Description	Price
<b>Technodes: Swimming Pool Anodes</b>		
TN-LD	Ladder Anode – Sold in Pairs	40.00/pair
TN-LT	Light Anode	24.95
TN-IL	Inline Anode – 1 ½” & 2”	66.00
TN-100	Inline Replacement Zinc For TN-IL – 1 ½” & 2”	24.00
TN-SK	Utility Anode/Skimmer Weight	18.95



**TN-LAD**  
LADDER TECHNODE

- SACRIFICIAL ZINC ANODE
- HIGH SURFACE TO VOLUME RATIO
- FITS ALL 1.9 INCH LADDER RAILS
- COMPACT DESIGN WILL NOT INTERFERE WITH SWIMMERS

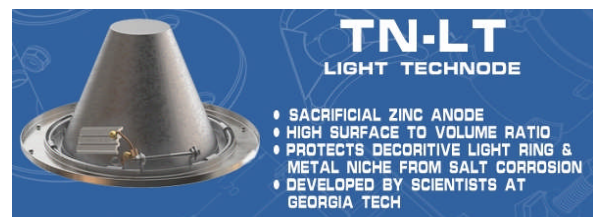

**TN-LT**  
LIGHT TECHNODE

- SACRIFICIAL ZINC ANODE
- HIGH SURFACE TO VOLUME RATIO
- PROTECTS DECORATIVE LIGHT RING & METAL NICHE FROM SALT CORROSION
- DEVELOPED BY SCIENTISTS AT GEORGIA TECH



**TN-IL**  
INLINE TECHNODE

- ANODE CONNECTS DIRECTLY TO METAL FILTER OR HEATER CORE
- CLEAR PVC CONSTRUCTION FOR EASY ANODE INSPECTION
- SIMPLE ANODE REPLACEMENT
- WEATHERPROOF INSTALLATION STICKER TO MONITOR SERVICE



**TN-SK**  
UTILITY TECHNODE

- SACRIFICIAL ZINC ANODE
- HIGH SURFACE TO VOLUME RATIO
- ATTACHES EASILY TO SKIMMER BASKET
- DEVELOPED BY SCIENTIST AT GEORGIA TECH

**What is a Sacrificial Anode?** A sacrificial metal anode is used to protect critical metal components in a salt system swimming pool. The sacrificial anode is connected electrically (either through direct contact or by use of a wire) to the metal to be protected. In a salt system pool, for example, a pool heater core will normally tend to corrode as a result of being in contact with the pool water. If this heater core is connected to a properly designed sacrificial anode, the anode will tend to corrode and transfer electrons to the heater core. At the interface between the pool water and heater core these electrons will create a chemical reaction that protects the heater core. The heater core (**cathode**) attracts electrons produced by the corroding sacrificial anode. The electrons react at the surface of the heater core with elements in the water. This reaction protects the heater core at the expense of the sacrificial anode. This transfer of electrons from the sacrificial anode to the metal to be protected is referred to as **Cathodic protection**. Cathodic Protection is illustrated to the right.

**Examples of Sacrificial Anodes:** All water heaters utilize sacrificial anodes to protect their steel tanks from corroding. The single most important factor in whether a water heater lives or dies is the condition of its sacrificial anode. Ships have anodes installed on their hulls to protect the steel hull from corroding in sea water. Lobster traps utilize sacrificial anodes to prevent corrosion on the ocean floor. Off shore oil rigs, buried pipelines, storage tanks, steel piers, and oil wells all utilize sacrificial anodes to prevent corrosion and premature failure of their critical components.

**Why use TechNodes:** TechNodes are the result of research done by Scientists at the Georgia Institute of Technology. TechNodes are sacrificial anodes designed specifically to protect critical metal components in Salt System Swimming Pools. TechNode In-line is designed to protect any metal components in the pools plumbing, including pool heaters and heat exchangers. TechNode Ladder will protect pool ladders that are submerged in the swimming pool. TechNode Light will prevent corrosion of metal components on underwater lights. TechNode Utility is designed to protect any other metal components in the swimming pool. TechNodes are cast from Mil Spec Zinc, have high surface area to volume characteristics resulting in the most efficient Pool Anodes on the market.

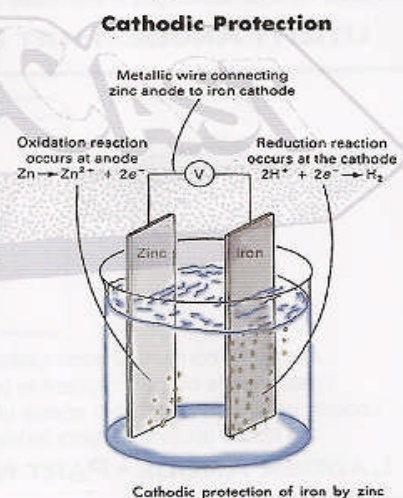

# PoolCo USA

## Safety Equipment - Continued

### Aqua Sensor- Pool Alarms

Swim Alert- MSRP \$599.00	780.00
Espio- MSRP \$699.00	910.00



SUMMARY OF KEY FEATURES
• Exclusive <b>Aquasensor</b> fall detection technology
• <b>ASTM F2208-02</b> Certified
• Magnetic keys for poolside activation/deactivation
• Strong poolside alarm- 100 db
• Strong indoor wireless remote alarm (85db) with 100' range
• Effective in pools up to 20' x 40' (1,000sft)
• Automatic rearming after bathing
• All installation hardware included
• Alarm Failure signals
• Low battery light
• Batteries included (4 "D")
• Chemical and UV-resistant materials of construction
• Two-year limited warranty
• Poolside unit dimensions: 9.5" x 9" x 2.5"
• <b>UL</b> listed
• <b>NSF</b> certified

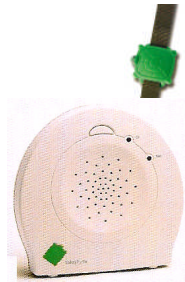

Safety Turtle		
<b>B101</b>	Base Station- AC adapter, & user guide (Eng. & Spanish)	139.00
<b>T101G,B,R,Y,or P</b>	Turtle Wristband- Baby turtle plug for base station, key for locking buckle, Comes in Green, Blue, Red, Yellow, or purple	69.00
<b>P101</b>	Turtle Power- Battery pack & waterproof carrying bag	119.00

### Other Safety Equipment

55584	Throwline-60 ft.	18.95
55553	Pool Ring-19"	34.00
55554	Pool Rings-24"	38.00
55549	USCG Approved Ring Buoys- 19" white	89.00
55550	USCG Approved Ring Buoys- 24" white	110.00



### Rope Kits- 2-Hook Ropes

<b>RFK16</b>	16' Rope Kit	32.00
<b>RFK18</b>	18' Rope Kit	39.00
<b>RFK20</b>	20' Rope Kit	42.00
<b>RFK22</b>	22' Rope Kit	45.00
<b>RFK25</b>	25' Rope Kit	48.00
	Twist Lock Pool Floats- 3" x 5"	4.50

# PoolCo USA

## Deck Jets & Fountains

### Deck Jets

Designed for residential pools, but with features only found on higher priced commercial water features. Eyeball is hidden from view by decorative cap. Four different cap colors are included with each deck jet. A variety of plumbing choices makes this deck jet easier to install. Only takes 3-5 GPM for a stream of water up to 10 feet high. Made for simple installation and trouble-free operation.



### Deck Jets

25597-000-000 | Deck Jet Assembly | \$ 90.00

#### Features:

- Individually Packaged
- Includes body, adjustable nozzle and four colored, round decorative caps (white, black, gray, tan)



### Deck Jet and Wall Jet Specifications

GPM	3 GPM	4 GPM	5 GPM
Feet of Head	3.9	7.9	11
Height of Water Stream	3 Ft	6.5 Ft	10 Ft

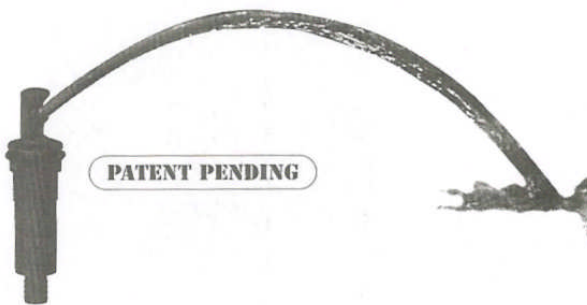

### Pop-UP Deck Jets

675-0700	3/4" Ribbed barb	\$ 35.00
675-0710	3/4" Smooth barb	\$ 35.00
675-0720	3/4" Socket	\$ 35.00
675-0730	1/2" Socket	\$ 35.00

#### POP-UP WATER FEATURE

##### Features:

- ❶ Pops up when pressurized.
- ❷ Drops down when unpressurized.
- ❸ Solid 7/16" rod shaped water stream, projects at 45° angle
- ❹ Available in several body styles and colors.
- ❺ Max. flow 4.76 GPM @ 3 PSI = 48" cascade.

### Fountains

180005	Waterfall Fountain	22.00
180006	Flower Fountain	22.00
180010	Grecian Fountain	44.00
180015	Rock Fountain	46.00
8592	Swan Floating Fountain- Triple Tier	75.00
8590	25' Fountain Transparent replacement hose	10.00



180010

# PoolCo USA

## Hef-T-Pad

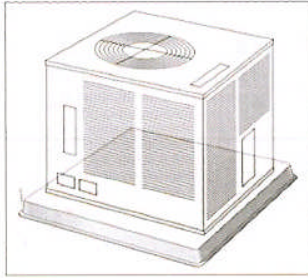

### HEF-T-PAD™ Features:

- Injection molded from high impact polyolefin for strength and durability.
- Resistant to impact, UV degradation and weathering.
- Will not crack, flake or warp.
- Virtually impervious to climate changes.
- Drillable, permits installation of refrigerant and electrical lines under and through pad. Also permits equipment to be easily secured to pad.
- Unique, non-creep surface absorbs vibration and noise and keeps equipment in it's original position.
- Gray



Underside of Hef-T-Pad showing support ribs, stabilization pads and stabilization flange.

Product No.	Description	Price
X2430211	24" x 30" x 2" Hef-T-Pads	34.00
X3232211	32" x 32" x 2" Hef-T-Pads	44.00
X3030311	30" x 30" x 3" Hef-T- Pads	42.00

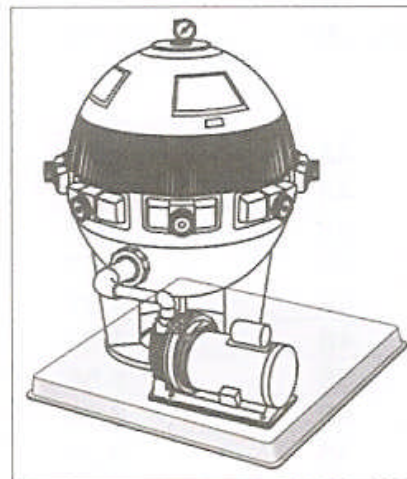
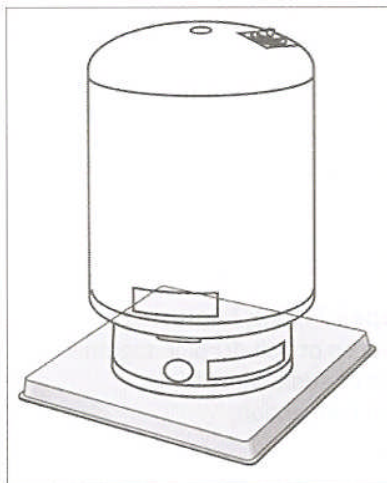

# PoolCo USA

## Pool Paints

### NATIONAL POOL FINISHES



Item No.	Product	Price
R100	Pool Shield CRX, 1 gal.	93.00
R500	Pool Shield CRX, 5 gal.	446.00
S100	Pool Shield, 1 gal.	82.00
S500	Pool Shield, 5 gal.	386.00
*E200EHB	Pool Guard EHB, 2 gal. Epoxy kit	236.00
E200	Pool Guard, 2 gal. Epoxy kit	230.00
AK100	Aqua Kote, 1 gal.	83.00
AK500	Aqua Kote, 5 gal.	409.00
DK100	Deck Kote, 1 gal.	88.00
DK500	Deck Kote, 5 gal.	429.00

\*EHB= Extra Heavy Body

### Pool Colors

Stocked  
White:



Medium Blue:



Sky Blue:



Non-Stocked  
Aqua:



Royal Blue:

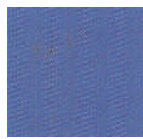

(Drop ship available)

Stripe Colors: Limited Stock

Deck Colors: 9 colors Available; Limited Stock, call before ordering.

### Cross Reference Chart

<u>National</u>	<u>Ramuc</u>	<u>Olympic</u>
POOL SHIELD CRX	Type A Chlorinated Rubber	Paralon 2
POOL SHIELD	Pro 2000 Chlorinated Rubber	Optilon
POOL GUARD EHB	Epoxy EP High Build	Zeron
POOL GUARD	Type EP Epoxy	Poxilon
AQUA KOTE	Type DS Acrylic	Hydrolon
DECK KOTE	Type ADC Acrylic Deck Coat	Patio Tones



# PoolCo USA

IPS CORPORATION  
**IPS**

**WELD-ON**

The Leader in Innovative Products  
for the Plastic Pipe Industry



**700**

Regular Bodied, fast setting, PVC Cement for all classes and schedules with interference fit through 4" diameter (except Schedule 80). This product may also be used on PVC foam core pipe.

**CLEAR**  
3 Year Shelf Life  
Meets ASTM D-2564



10080	700 PVC Regular Body Clear- Pint	8.00
10078	700 PVC Regular Body Clear- Gallon	38.00



**725 Wet 'R' Dry**

Medium bodied, extremely fast setting, PVC cement for all classes and schedules with interference fit through 6" diameter, Schedule 80 through 4" diameter. Specially formulated for rigid and flexible applications where conditions are wet and/or when quick pressurization is desired. Can be used without primer on non-pressure systems if local codes permit.

**AQUA BLUE**  
3 Year Shelf Life  
Meets ASTM D-2564



10166	725 PVC Wet "R" Dry Aqua Blue-Pint	15.00
-------	------------------------------------	-------



**747 Pool 'R' Spa**

Medium bodied, extremely fast setting, PVC cement for all classes and schedules with interference fit through 6" diameter, Schedule 80 through 4" diameter. Developed for rigid & flexible applications, wet conditions and/or quick pressurization. Can be used without primer on non-pressure systems if local codes permit

**BLUE (fades to CLEAR)**  
3 Year Shelf Life  
Meets ASTM D-2564



10853	747 PVC Pool "R" Spa Blue- Pint	9.00
10851	747 PVC Pool "R" Spa Blue- Gallon	50.00



**PC-64 Primer- Cleaner**

For Cleaning and surface preparation of PVC and CPVC pipe fittings.

**PURPLE/CLEAR**  
3 Year Shelf Life

10873	PC-64 Primer-Cleaner Purple- Pint	8.00
10871	PC-64 Primer-Cleaner Purple- Gallon	46.00



**Glue-Mate**

2000	Glue-Mate	16.00
DB-1	Dauber Cap-32 oz.	.75