

PoolCo USA

Skimmers & Returns

ASTRALPOOL



Wide-Mouth Vinyl Skimmer

Outside mount on steel wall pool. High quality injection molded ABS body with external ribs for superior strength. Skimmer features unique triple connections; two standard 2" slip plus a third, optional connection with a molded 90° elbow for easier installation in rocky soil conditions. Round cover with 1/4" adjustment. For square lid applications add "Sq" to end of reference number.



Skimmer includes weir flap, vacuum plate, basket and installation hardware. Top access unit features 6"x5 1/2" mouth for superior skimming action. Vacuum plate allows for use of either 1 1/4" or 1 1/2" vacuum hose and bottom skimmer connection is 1 1/2". Gaskets and face plate included. Skimmer package also includes ABS return fitting which will accommodate 1 1/4" or 1 1/2" return hose. Quality construction at a competitive price!

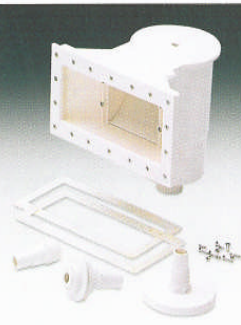

Wide Mouth Above Ground Skimmer

Same features as 09707, with dimensions of wide mouth; fits industry standard hole pattern.



Inlet/Outlet Fitting-Vinyl Liner, In-Ground-1 1/2"

2" external thread. Constructed in white ABS. Gaskets and hardware included. Must purchase Directional Flow or Multiflow Fitting separately.

Reference	List Price	Standard Carton	Carton Weight (lbs.)	Carton Volume (ft ³)
Wide-mouth Vinyl Skimmer				
15560	170.00	1	13.2	3.0
Standard Vinyl Skimmer				
15559	140.00	1	13.2	3.0
Extension Collar				
05280	8.00	1	1	N/A

09707	42.00	1	11	2.3
-------	-------	---	----	-----

20891	60.00	1	13	3.0
-------	-------	---	----	-----

22349	9.95	12	10	0.71
-------	------	----	----	------

PoolCo USA

Waterway Skimmers

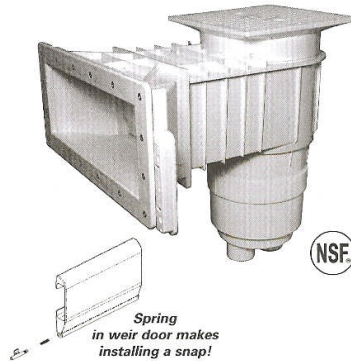

FEATURES

- PVC sockets for better glue joints.
- 2" socket is 2 1/2" spigot for more flow.
- 1 1/2" socket is 2" spigot for easier plumbing.
- 1/2" socket for overflow hose.
- Large locking skimmer basket.
- Easy access spring-loaded weir door simplifies replacement.
- Optional float valve.
- Optional skimmer test kit.
- Lock-Down vacuum plate included.

Renegade Vinyl Liner Skimmer (In-Ground Application)

Part No.	Description	Throat	Color	Price
540-8430	Standard Vinyl Liner In-Ground Skimmer 1 1/2" Socket	--	White	165.00
540-8537	Wide-mouth Vinyl Liner In-Ground Skimmer 1 1/2" Socket	9"	Gray	220.00
540-8530	Wide-mouth Vinyl Liner In-Ground Skimmer 1 1/2" Socket	9"	White	194.00
Accessories				
519-9520	Standard Vinyl Liner Trim Plate	--	White	9.00
519-9540	Wide-mouth Vinyl Liner Trim Plate	--	White	11.00
519-6570	Extension ring (1 ring comes with each of the skimmers above)		White	9.00

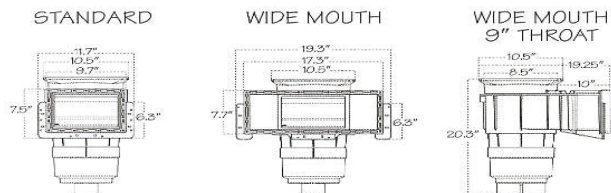

Waterway's Vinyl Liner In-Ground Skimmer is designed for better and easier installations while maximizing flow. The large skimmer basket locks into place and will not float up. High flow rate of 75 gallons per minute.

Flo-Pro II (Above Ground Application)

Part No.	Description	Wt. (lbs)	Color	Price
560-D0C60S	Standard Skimmer-Long Throat with return	5	White	48.00
560-C3C60L	Wide-mouth Skimmer- Short Throat with return	7	White	69.00

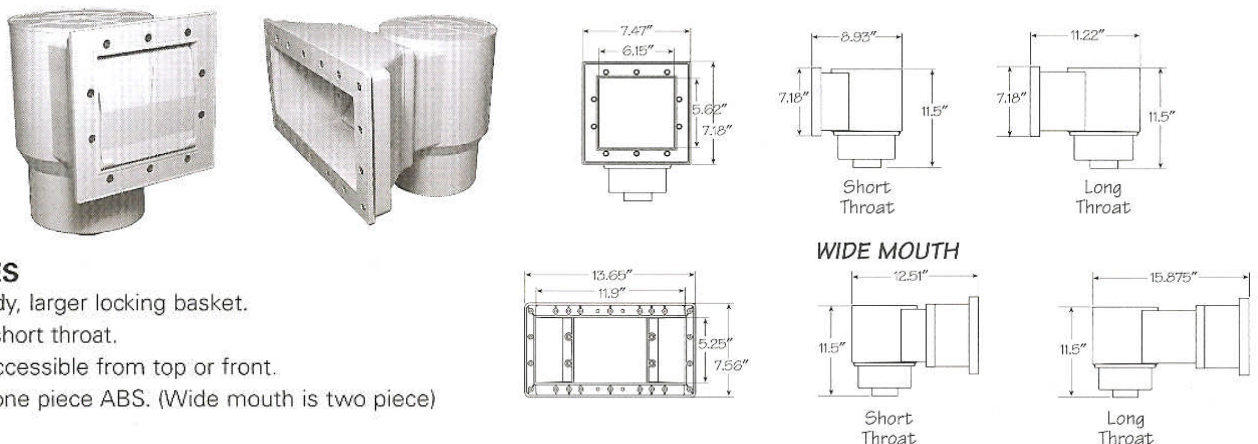

FEATURES

- Deep body, larger locking basket.
- Long or short throat.
- Basket accessible from top or front.
- Durable one piece ABS. (Wide mouth is two piece)
- 1 1/2" FPT.
- 1 1/2" hose adapter included.

PoolCo USA



Waterway Concrete Main Drains

Waterway's wide selection of pool drains and drain covers simplifies installation for new or existing pools and spas. We manufacture our drain bodies in PVC for better glue joints or threaded connections. Always use two or more drains per pump.



675-320xV



640-2520



640-2310



640-4700



Bottom x Bottom Main Drains

Part No.	Description	Color	Case Qty.	Price
640-2320	Anti-vortex 1½" Socket	White	6	38.00
640-2321	Anti-vortex 1½" Socket	Black	6	38.00

Side x Bottom Main Drains

640-2420V	Anti-vortex 1½" Socket	White	8	34.00
640-2520V	Anti-vortex 2" Socket	White	8	34.00
640-2550V	Anti-vortex 2" FPT	White	8	34.00

Cover & Frames - Misc. Main Drains

640-231xV	Anti-vortex Cover & Frame	White	25	18.00
640-2311V	Anti-vortex Cover & Frame	Black	25	18.00
640-2317	Anti-vortex Cover & Frame	Gray	25	18.00
640-2319-BEI	Anti-vortex Cover & Frame	Beige (Tan)	25	18.00
640-2319-DKB	Anti-vortex Cover & Frame	Dark Blue	25	18.00
640-3110	10" A/V Pool Cover & Frame	White	30	32.00
640-3111	10" A/V Pool Cover & Frame	Black	30	32.00
640-3117	10" A/V Pool Cover & Frame	Gray	30	32.00
640-3119-DKG	10" A/V Pool Cover & Frame	Dark Gray	30	32.00
640-3119-BEI	10" A/V Pool Cover & Frame	Beige	30	32.00
640-2410	8" Main Drain Std. W/ 2 ½" x S	White	1	63.00
640-2830	Same as above but w/Adj. Collar	White	1	73.00
672-2610	8" Deep Sump M.D. 2 1/2 " x S	White	7	14.00
640-4700	9" x 9" Grate & Frame	White	18	70.00
640-4701	9" x 9" Grate & Frame	Black	18	78.00
640-4707	9" x 9" Grate & Frame	Gray	18	78.00
640-4709-DKG	9" x 9" Grate & Frame	Dark Gray	18	78.00
640-4709-BEI	9" x 9" Grate & Frame	Beige (Tan)	18	78.00
640-4730	9" x 9" Universal Grate	White	18	52.00
675-320xV	9" x 9" Fiberglass Sump Ass'y	---	1	375.00
675-310xV	12" x 12" Fiberglass Sump Ass'y	---	1	445.00
640-4720	12" x 12" Grate & Frame	White	14	106.00
640-4721	12" x 12" Grate & Frame	Black	14	118.00
640-4727	12" x 12" Grate & Frame	Gray	14	118.00
640-4729-DKG	12" x 12" Grate & Frame	Dark Gray	14	118.00
640-4729-BEI	12" x 12" Grate & Frame	Beige (Tan)	14	118.00
640-4740	12" x 12" Universal Grate	White	14	72.00

PoolCo USA

Vinyl Main drains

Waterway's Wide selection of pool drains and drain covers simplifies installation for new or existing pools and spa's. Main drain sump bodies are PVC, better for plastic gluing sockets and threading adapters than ABS. Vinyl liner main drains come with a stay-in-place gasket, eliminating the need to glue a gasket to the body before installation. Always use two or more drains per pump.

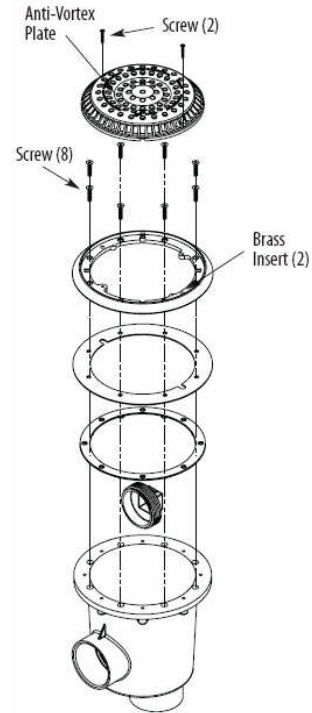

Waterway® Vinyl Liner Main Drains			
Part No.	Description	Color	Price
640-2660	Anti-Vortex 1 1/2" Socket	White	41.00
640-2667	Anti-Vortex 1 1/2" Socket	Gray	43.00
640-2750	Anti-Vortex 2" Socket	White	43.00



Vinyl Main Drain w/ 8" Galaxy Lid & Ring
 8 per box
 25515-000
 • 2" Side Opening, 2" Bottom Opening
 • Includes Bushings & Plug
 • Extra Deep Threads for Easy Pressure Testing
 • 95 GPM (Floor Only)
Replacement Gasket
 25515-000-011
Replacement Lid
 25507-100-010

VGB 2008 USPC

CMP® Vinyl Liner Main Drains			
Part No.	Description	Color	Price
25515-000	1 1/2" & 2" Combo Vinyl/FG Pool Main Drain	White	43.00
25515-001	1 1/2" & 2" Combo Vinyl FG Pool Main Drain	Grey	43.00
25597-100	Replacement VGB drain cover-Fits SP1048 Hayward	White	19.00
255	Above Hay. repl. VGB drain cover with adapter ring	White	22.00

PoolCo USA



Waterway Fittings

Deluxe return fitting assy 1" eyeball (with Gasket)

Part No.	Description	Case Qty.	Color	Price
550-9340	bulk packed	45	White	12.00



1" Eyeball
(400-1410E)

Return wall fitting Assy (with nut & Gasket) 1 1/2" FPT thru

Part No.	Description	Case Qty.	Color	Price
400-9170	bulk packed	50	White	7.00
400-9177	bulk packed	50	Gray	8.00



1" Eyeball Opening 1 1/2" MPT

Part No.	Case Qty.	Color	Price
400-1410E	125	White	3.00
400-1417E	125	Gray	3.50

3/4" Eyeball Opening 1 1/2" MPT

Part No.	Description	Color	Price
400-1410D	125	White	3.00
400-1417D	125	Gray	3.50

Steel wall Vinyl liner fitting Ass'y with combo spacer & locknut

Part No.	Description	Case Qty.	Color	Price
400-9160B	1 1/2" FPT x 1 1/2" FPT	25	White	10.50
400-9060B	1 1/2" FPT x 1 1/2" Socket	25	White	10.50
400-9067B	1 1/2" FPT x 1 1/2" Socket	25	Gray	12.00



Wall Fitting Escution

Part No.	Description	Case Qty.	Color	Price
218-1440	bulk packed	200	White	2.00
218-1447	bulk packed	200	Gray	2.50



Spa Rotating Therapy Massage Jet 1 1/2" MPT

Part No.	Description	Case Qty.	Color	Price
212-9170	Individually Bagged	50	White	22.00
212-9177	Individually Bagged	50	Gray	22.00

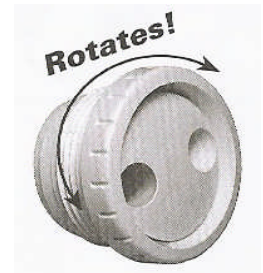

Directional Eye for Spas (same as Hydro-Air 5100 series)

Part No.	Description	Case Qty.	Color	Price
210-4120	1 1/2" S x 1 1/2" S	24	White	24.00



6" Valve Niche Ass'y (Cover & Flange)

Part No.	Description	Case Qty.	Color	Price
540-3160	Individually Bagged	30	White	14.00

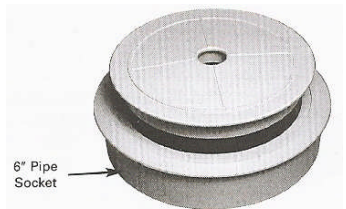

Ladder Flange with Support Opening - While Supplies Last

Part No.	Description	Case Qty.	Color	Price
429-4020	Bulk packed	175	White	3.00
429-4027	Bulk packed	175	Gray	3.00

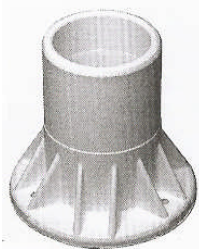

PoolCo USA



Valves & Unions



TruSeal 3-Way Diverter Valves

Part No.	Description	Price
600-7100-CPVC	2" Socket x 2 1/2" Spigot- CPVC Body	72.00
600-7200-CPVC	1 1/2" Socket x 2" Spigot- CPVC Body	68.00

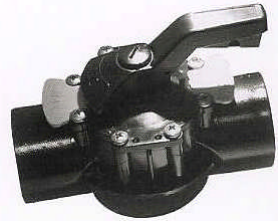

TruSeal 2-Way Diverter-Straight Body

600-7060-CPVC	2" Socket x 2 1/2" Spigot- CPVC Body	64.00
600-7070-CPVC	1 1/2" Socket x 2" Spigot- CPVC Body	59.00

TruSeal 2-Way Diverter-90° Body

600-7040-CPVC	2" Socket x 2 1/2" Spg- CPVC Body	64.00
600-7050-CPVC	1 1/2" Socket x 2" Spg- CPVC Body	59.00



TruSeal Check Valve-Straight Body

600-7010	2" Socket x 2 1/2" Spigot- Black CPVC Body	54.00
600-7030	1 1/2" Socket x 2" Spigot- Black CPVC Body	48.00



TruSeal Check Valve-90° Body

600-7000	2" Socket x 2 1/2" Spigot- Black CPVC Body	54.00
600-7020	1 1/2" Socket x 2" Spigot- Black CPVC Body	48.00

Miscellaneous Valves & Unions

6101	1 1/2" Deluxe Gate Slice Valve- S x S Valterra	15.00
6201	2" Deluxe Gate Slice Valve- S x S Valterra	23.00
11378	Astral Ball Valve- 1 1/2" Socket x MIP	22.00
15695	Astral Ball Valve- 2" Socket x Socket	26.00
2161	1 1/2"/2" 3-Way PVC Valve- S x S x S -Valterra	39.00
80UN15	1 1/2" Schedule 80 Union- S x S x Union	13.00
80UN20	2" Schedule 80 Union- S x S x Union	16.00
40UN15	1 1/2" Schedule 80 Union- S x S x Union	10.00
40UN20	2" Schedule 40 Union- S x S x Union	14.00

PoolCo USA

Circulation Fittings

In-Ground (Vinyl/Fiberglass) Skimmers

Model No.	Description	Pipe Size	Cover Style	Throat Length	Price
SP108410M	Auto Skim Series	1 1/2" FIP	Square	8 1/2"	169.00
SP108520M	Auto-Skim Wide Track Series	1 1/2" FIP	Square	9 1/4"	206.00
SP1097	Auto-Skim PT & Econ. Series	1 1/2" FIP	Round	12 1/2"	140.00

* All skimmers are packed with a face plate, gaskets, and screws.

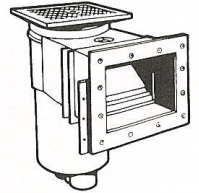

SP10841

Skimmer Accessories

Model No	Description	Price
SP1084F	Face plate cover-"Snap On," for SP1084- white	8.50
SP1085F	Face plate cover-"Snap On," for SP1085- white	10.00
SP1084P1	Extension collar for SP1084 and SP1085	10.00
SP1106	Vac Plate w/ rubber gasket for large skimmers	14.00

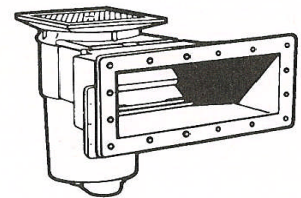

SP108510M

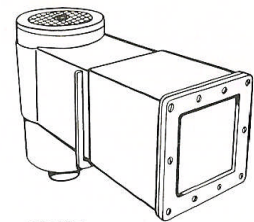

SP1097

Main Drains ASME/ANSI-VGB Compliant

Model No.	Type	Size	Price
WG1048AV- Pair	(2) Vinyl/Fiberglass Drains	1-1/2	96.00

Pool Fittings

Model No.	Pipe Size	Description	Price
SP1419C,D,E	1 1/2" MIP	Hydro stream 1/2", 3/4", 1 opening	2.75
SP1023	1 1/2" FIP	Fitting with locknut and gaskets	8.50
SP1408	1 1/2" x 1 1/2" FIP	Locknut/spacer with face thread in body	10.50
SPX1091Z7	1 1/2" MIP	Male adapter 1 1/2"/1 1/4" combo hose	1.50

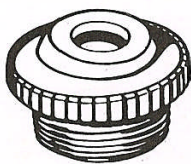

SP1419D

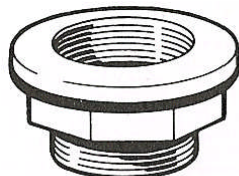

SP1023

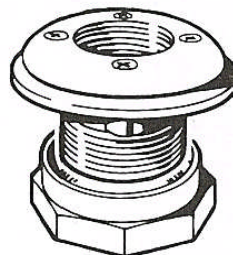

SP1408

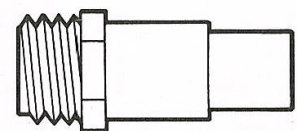

SPX1091Z7

PoolCo USA

LASCO® Fittings, Inc.

Schedule 40 PVC Fitting

Tee



(slip x slip x slip)

90 Ell



(slip x slip)

45 Ell



(slip x slip)

Coupling



(slip)

Female Adaptor



(slip x FIPT)

Tee



(insert)

Male Adaptor



(insert x MIPT)

Part No.	Description	Size	Case qty.	Price
401-015	Tee (slip x slip x slip)	1 1/2"	25	2.00
401-020	Tee (slip x slip x slip)	2"	25	3.00
401-025	Tee (slip x slip x slip)	2 1/2"	10	9.00
401-030	Tee (slip x slip x slip)	3"	10	12.00
402-209	Reduce Tee (slip x slip x FIPT)	1 1/2" x 1 1/2" x 1/2"	25	3.80
402-210	Reduce Tee (slip x slip x FIPT)	1 1/2" x 1 1/2" x 3/4"	25	3.80
406-015	90 Ell (slip x slip)	1 1/2"	25	1.60
406-020	90 Ell (slip x slip)	2"	25	2.40
406-025	90 Ell (slip x slip)	2 1/2"	10	7.00
406-030	90 Ell (slip x slip)	3"	10	8.00
407-015	90 Combo (FIPT x slip)	1 1/2"	25	2.50
409-015	90 Street Ell (sp x slip)	1 1/2"	25	3.10
410-015	90 Street Ell (MIPT x slip)	1 1/2"	25	2.50
411-015	90 Street Ell (sp x FIPT)	1 1/2"	25	3.00
417-015	45 Ell (slip x slip)	1 1/2"	25	2.25
417-020	45 Ell (slip x slip)	2"	25	2.80
417-025	45 Ell (slip x slip)	2 1/2"	10	7.00
417-030	45 Ell (slip x slip)	3"	10	11.00
429-015	Coupling (slip)	1 1/2"	25	0.96
429-020	Coupling (slip)	2"	25	1.56
429-025	Coupling (slip)	2 1/2"	10	3.20
429-030	Coupling (slip)	3"	10	5.00
429-251	Reducer Coupling (slip)	2" x 1 1/2"	10	3.20
435-015	Female Adaptor (slip x FIPT)	1 1/2"	25	1.25
435-020	Female Adaptor (slip x FIPT)	2"	25	2.00
435-025	Female Adaptor (slip x FIPT)	2 1/2"	10	4.50
435-030	Female Adaptor (slip x FIPT)	3"	10	6.00
436-015	Male Adaptor (MIPT x slip)	1 1/2"	25	1.20
436-020	Male Adaptor (MIPT x slip)	2"	25	1.60
436-025	Male Adaptor (MIPT x slip)	2 1/2"	10	4.40
436-030	Male Adaptor (MIPT x slip)	3"	10	6.60
437-210	Reducer Bushing (sp x slip)	1 1/2" x 3/4"	25	1.20
437-292	Reducer Bushing (sp x slip)	2 1/2" x 2"	10	3.00
437-338	Reducer Bushing (sp x slip)	3" x 2"	10	4.20
437-339	Reducer Bushing (sp x slip)	3" x 2 1/2"	10	4.20
438-209	Reducer Bushing (sp x FIPT)	1 1/2" x 1/2"	25	2.00
438-210	Reducer Bushing (sp x FIPT)	1 1/2" x 3/4"	25	2.00
438-251	Threaded Bushing (MIPT x FIPT)	2" x 1 1/2"	10	3.40
Insert Fittings-pvc				
1401-015	Tee (insert)	1 1/2"	10	3.80
1406-015	90 Ell (insert x insert)	1 1/2"	10	2.40
1407-015	Combo Reducer 90 Ell (ins x FIPT)	1 1/2" x 1 1/2"	10	3.70
1413-015	Combo 90 Ell (insert x MIPT)	1 1/2"	10	5.20
1429-015	Coupling (insert x insert)	1 1/2"	20	1.40
1435-015	Female Adaptor (insert x FIPT)	1 1/2"	15	5.20
1436-015	Male Adaptor (insert x MIPT)	1 1/2"	20	1.40
Schedule 80 PVC Nipples				
215-017	Nipples	1 1/2" x close	25	1.80
215-040	Nipples	1 1/2" x 4"	25	2.70
215-060	Nipples	1 1/2" x 6"	25	3.50
215-080	Nipples	1 1/2" x 8"	25	4.50
215-120	Nipples	1 1/2" x 12"	25	6.00

Orders of 2 cases or more receive an additional discount – we have other sizes of above nipples.