

PoolCo USA



MAGNUM MAGNUM FORCE PUMPS



- Patented air-cooled heat sink allows pump to run dry without damage to shaft seal. UNCONDITIONAL ONE-YEAR WARRANTY AGAINST SEAL FAILURE. Exclusive dual Ring-Lok design gives "tool free" access to strainer basket and pump internals. 183 cu. in. pre-filter. Transparent cover providing tight closure. No tools required for disassembly.
- Housing molded from a single reinforced corrosion-resistant thermoplastic piece with two drain plugs with winterization. Floating eye seal between closed impeller and diffuser maximizes efficiency. Mechanical seal with identical ceramic and carbon surfaces. All other components are made of BUNA-N rubber and stainless steel. Seal is heat and leak resistant.
- Included with Magnum pump two 2"x1-1/2" PVC reducers and Magnum Force pump has two 2" half unions.

Magnum Single Speed- While Supplies Last -Call for Availability				
Model	HP	Voltage	Service Factor	Price
7UMF-S	¾	115/230	1	800.00
Stocked 1UMF-S	1	115/230	1.25	840.00
15UMF-S	1 ½	115/230	1.1	950.00
2UMF-S	2	115/230	1.1	1,150.00



Magnum Force-Single Speed-While Supplies Last -Call for Availability

Model	HP	Voltage	Service Factor	Price
7MAG-U-S	¾	115/230	1	800.00
1MAG-U-S	1	115/230	1.25	840.00
15MAG-U-S	1 ½	115/230	1.1	950.00
2MAG-U-S	2	115/230	1.1	1,150.00

PoolCo USA

HAYWARD Pumps HAYWARD POOL PRODUCTS

One source. Every pool.

Super Pump®

HIGH PERFORMANCE PUMP



SP2610X15 1 1/2 H.P. Super Pump.



Overall Dimensions

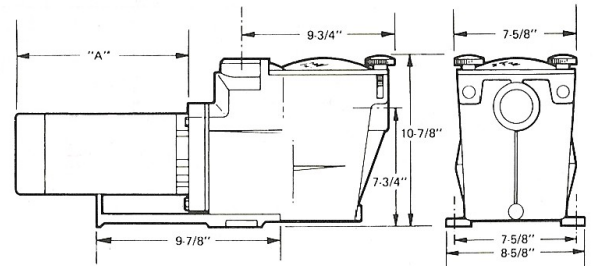

<i>Super Pump</i>					
Model No.	H.P.	Voltage	Pipe Size	Dim "A"	Price
Single Speed					
SP2605X7	3/4	115/230	1 1/2"	10 5/8"	1,360.00
SP2607X10	1	115/230	1 1/2"	11"	1,480.00
SP2610X15	1 1/2	115/230	1 1/2"	12 1/8"	N/A
SP2615X20	2	115/230	2	13 1/8"	N/A
Speed Dual					
SP2607X102S	1	230	1 1/2"	13 5/8"	2,100.00
SP2610X152S	1 1/2	230	1 1/2"	14 1/8"	N/A
SP2615X202S	2	230	2	15 1/8"	N/A
Dual speed pumps with "S" designation are complete with "Hi/Lo" switch.					



Power-Flo® Matrix™

ABOVE-GROUND PUMP SERIES

Overall Dimensions

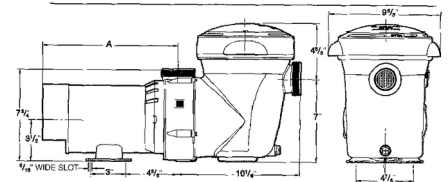

<i>Power-Flo Matrix</i>				
Model No.	H.P.	Voltage	Pipe Size	Price
SP1591	3/4	115	1 1/2"	790.00
SP1592	1	115	1 1/2"	830.00
SP1593	1 1/2	115	1 1/2"	880.00

PoolCo USA

Pooline Products Pumps



12743



12747 & 12748



12729



12715

Pooline Products- Single Speed- Unity Service Factor				
Model	HP	Voltage	Type	Price
12743	1	115	In-Ground w/6'cord	440.00
12747	1	115/230	In-Ground	480.00
12748	1 ½	115/230	In-Ground	510.00
B8376	1	115	Above-Ground w/6'cord	390.00
B8377	1 ½	115	Above-Ground w/6'cord	450.00
12715	.35	115	Small A/G System w/cord	340.00



1-1/2" & 2" Union adapters available for above units @ \$3.00 & \$5.00 each

PoolCo USA

Waterway VS Pumps

The innovative energy efficient and user friendly design of the Waterway Power Defender 140 Variable Speed Pump, 1.4 HP saves you money and prolongs the life of your in ground pool's filtration system!

- Self-Priming Pool Filter Pump
- Built-In Freeze Protection.
- Super quiet operation.
- Standard Square Flange & C-Face Mounting
- Also Suitable for Above Ground Pools.

Designed,
Engineered &
Manufactured
in the USA



- Waterway High performance & ultra quiet variable speed pool & spa pump provides you with up to 90% energy savings.
- Innovative, patent pending technology automatically actuates a diverter valve to direct the flow of water to the pressure pool cleaner and increase the pump speed and pressure.
- Built in pool control - easily program various day, time and speed settings, and actuate diverter valves to run in pool filtration, spill over and spa mode.
- The latest technology variable speed motors, totally enclosed construction with a powerful external fan - protects the motor against dirt and moisture and provides for extremely cool operation of the motor.
- Changes from 230V to 115V at the flip of a switch
- No drop in horsepower at either voltage!
- Energy Star approved



The Power Defender In-Ground Pool Pump

Part No.	Description	Volts	H.P.	Price
PC-140	1.4 HP Variable Speed Dual Voltage	115/230	1.4	1,680.00
PDVSC165	1.65 HP Variable Speed 230 Voltage	230	1.65	1,980.00
PDVSC270	2.7 HP Variable Speed 230 Voltage	230	2.7	2,480.00

PoolCo USA

Waterway Pumps

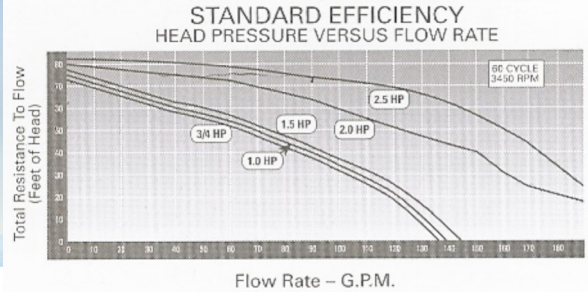
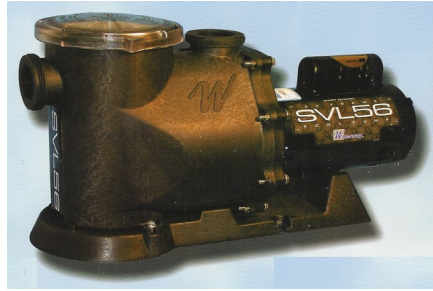

Waterway takes pride in introducing its new flagship in-ground premium pump in a class of its own. The extraordinary quietness of the SVL56 moves us nearer to the goal of silent operation, and it provides by far the best vertical lift. A true 56 frame motor ensures long life and uninterrupted power. Attention to detail is evident in the design of this all-new pump. Designed for easy serviceability and installation, the pump accepts either 2" or 2 1/2" plumbing connections and features dual bearings for cooler operating temperature. This pump will provide years of trouble-free

FEATURES

- Quiet operation.
- High efficiency.
- Self-priming.
- Best vertical lift at 24 ft.
- Easy to service.
- True 56 frame motor for cooler running and longer life.
- 2 1/2" union threads x 2" FPT with unions (included).
- Large trap basket with cam-lock lid.
- 60 Hz rating.

SLV56 In-Ground Pool Pump- Standard Efficiency- Maximum Rated

Part No.	Description	LIMITED STOCK	Volts	H.P.	WT. (lbs.)	Price
SVL56S-107	1 Speed- 2" or 2 1/2" Ports		115/230	.75	38	N/A
SVL56S-110	1 Speed- 2" or 2 1/2" Ports		115/230	1.0	40	1,040.00
SVL56S-115	1 Speed- 2" or 2 1/2" Ports		115/230	1.5	44	1,180.00
SVL56S-120	1 Speed- 2" or 2 1/2" Ports		230	2	46	1,490.00
SVL56S-125	1 Speed- 2" or 2 1/2" Ports		230	2.5	48	1,690.00

FEATURES:

- Super quiet operation
- 2" Unionized (Intake/Discharge)
- One piece pot and volute reduce noise
- Lower flow rates for more versatile installations

onal price with that of "Northst:

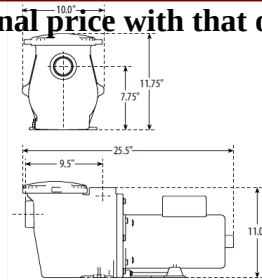

SupraMax Flow In-Ground Pool Pump

Part No.	Description	H.P.	Price
PD-110	1-Speed	1.1	860.00
SMF-115	1-Speed	1.5	890.00
SMF-120	1-Speed	2.0	N/A

PoolCo USA

Waterway Above Ground Pool Pumps



FEATURES:

- 1 1/2" Union threads / 1 1/2" FPT Intake and 2" Union threads / 1 1/2" FPT discharge
- Extra large 7" pump trap with clear lid
- Powerful side discharge performance
- Wet end easily rotates

PRESSURE VERSUS FLOW RATE

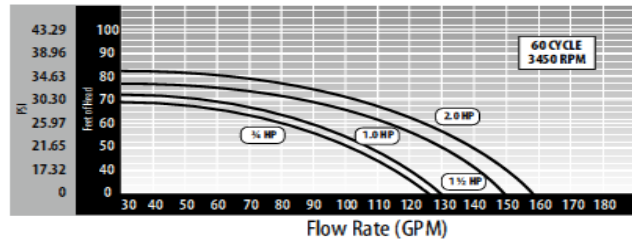

The Supreme Pump is the ultimate in above ground pool engineering. Designed for today's more demanding applications, the Supreme Pump is ideal for D.E., cartridge or sand filtration systems of all sizes.



Supreme 48-Frame Above Ground Pool Pump

Part No.	Description	Volts	H.P.	Amps	Price
PSP1075-6	1-Speed/6' NEMA Cord	115	3/4	10.78	510.00
PSP1000-6	1-Speed/6' NEMA Cord	115	1.0	13.2	540.00
PSP1150-6	1-Speed/6' NEMA Cord	115	1.5	13.2	570.00
PSP1200-6	1-Speed/6' NEMA Cord	115	2.0	18.04	600.00
PSP2075-6	2-Speed/6' NEMA Cord	115	3/4	10.78	630.00
PSP2100-6	2-Speed/6' NEMA Cord	115	1.0	13.2	650.00
PSP2150-6	2-Speed/6' NEMA Cord	115	1.5	13.2	670.00
PSP2200-6	2-Speed/6' NEMA Cord	115	2.0	18.04	690.00

FEATURES:

- 1 1/2" union threads / 1 1/2" FPT intake and 2" union threads / 1 1/2" FPT discharge
- Powerful side discharge performance
- Wet end can be rotated for easy installation
- Large 6" pump trap with one-piece clear lid
- High head capability
- Trap is 2" union x 1 1/2" union / 1 1/2" FPT



The Hi-Flo Above ground pump was designed for superior and efficient performance and features high flow performance for faster filtering cycles. This pump is ideal for new systems or as a replacement pump.

Hi-Flo Side Discharge 48-Frame Pump & Trap

Part No.	Description	Volts	H.P.	WT. (lbs.)	Price
PH1075-6	1 Speed- 6ft. NEMA cord	115	.75	26	470.00
PH1100-6S	1 Speed- 6ft. NEMA cord	115	1.0	30	500.00
PH1150-6S	1 Speed- 6ft. NEMA cord	115	1.5	33	540.00
PH1200-6	1 Speed- 6ft. NEMA cord	115	2.0	35	600.00

PoolCo USA

Waterway Spa Pumps

FEATURES:

- Executive wet end designed specifically for 56-frame motors
- Two double shielded ball bearings with moisture resistant grease for quieter operation and longer life
- Two speed motors have four sets of insulated windings for increased efficiency
- 56 frame motor for added strength, cooler operating temperature and longer motor life
- Large 2 1/2" intake for improved flow performance and reduced noise
- Large 6 1/2" diameter wet end for higher head pressure
- Split capacitor, (start and run) for less energy consumption
- Thermally protected to extend life expectancy of motor
- Highly versatile wet end can be rotated every 90°
- Viton seals
- Three year warranty on motor and wet end

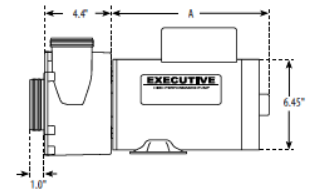
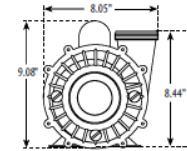

2-Speed Executive Pumps – 56 Frame

Part No.	Description	Volts	H.P.	Price
*3720821-1D	2" Intake – 2" Discharge A-Dimension=8.875"	230	2.0	709.00
3720821-13	2.5" Intake – 2" Discharge A-Dimension=8.875"	230	2.0	709.00
*3721221-1D	2" Intake – 2" Discharge A-Dimension=9.875"	230	3.0	759.00
3721221-13	2.5" Intake – 2" Discharge A-Dimension=9.875"	230	3.0	759.00
*3721621-1D	2" Intake – 2" Discharge A-Dimension=10.375"	230	4.0	829.00
*3721621-13	2.5" Intake – 2" Discharge A-Dimension=10.375"	230	4.0	829.00
*3722021-1D	2" Intake – 2" Discharge A-Dimension=10.375"	230	5.0	940.00
3722021-13	2.5" Intake – 2" Discharge A-Dimension=10.375"	230	5.0	940.00

* = In-Stock Items



FEATURES:

- Executive wet end designed specifically for 48-frame motors
- Large 2 1/2" intake for improved flow performance and reduced noise
- Large 6 1/2" diameter wet end for higher head pressure
- Thermally protected to extend life expectancy of motor
- Highly versatile wet end can be rotated every 90°
- Viton seals
- 2-year warranty on motor, 3-year on wet end

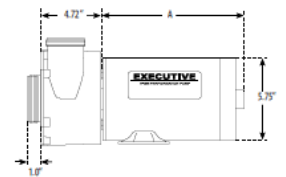
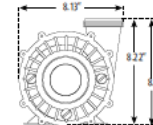

2-Speed Executive Pumps – 48 Frame

Part No.	Description	Volts	H.P.	Price
*3420820-1A	2" Intake – 2" Discharge A-Dimension=11.0"	230	2.0	709.00
3420820-13	2.5" Intake – 2" Discharge A-Dimension=11.0"	230	2.0	709.00
*3421221-1A	2" Intake – 2" Discharge A-Dimension=11.0"	230	3.0	759.00
3421221-13	2.5" Intake – 2" Discharge A-Dimension=11.0"	230	3.0	759.00
*3421821-1A	2" Intake – 2" Discharge A-Dimension=11.0"	230	4.5	829.00
3421821-13	2.5" Intake – 2" Discharge A-Dimension=11.0"	230	4.5	829.00
*3420610-1U	2" Intake – 2" Discharge EX2 Pump	115	1.5	680.00
*3420820-1U	2" Intake – 2" Discharge EX2 Pump	230	2.0	709.00

* = In-Stock Items

PoolCo USA

Waterway Spa Pumps Cont.

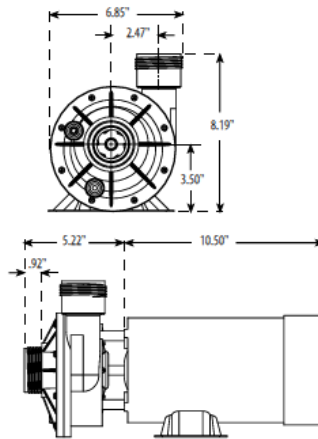

FEATURES:

- 48-frame proven design
- Designed for direct replacement in most spas
- Viton seals
- 1 1/2" Intake and Discharge

2-Speed Spa Flo Pumps – 48 Frame

Part No.	Description	Volts	H.P.	Price
*3420410-0Z	1.5" x 1.5" Spa Flo	115	1.0	580.00
*3420610-0Z	1.5" x 1.5" Spa Flo	115	1.5	480.00
*3420820-0Z	1.5" x 1.5" Spa Flo	230	2.0	620.00

* = In-Stock Items

FEATURES:

- High volume side discharge efficiency
- 60% more efficient than our center discharge pumps
- 2" intake and discharge
- Wet end can be rotated for easy installation
- Available in 1 to 4 HP, 1 or 2 speed
- Large 6 1/2" diameter wet end for higher head pressure
- Viton Seals
- 18 month warranty

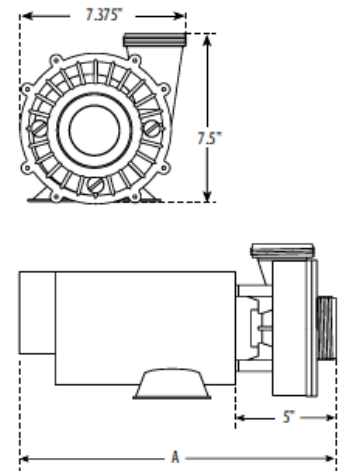

2-Speed Hi-Flo Pumps – 48 Frame

Part No.	Description	Volts	H.P.	Price
*3420410-10	2" x 2" Hi-Flo A-Dimension=14.73"	115	1.0	580.00
*3420610-10	2" x 2" Hi-Flo A-Dimension=15.48"	115	1.5	520.00
*3420620-10	2" x 2" Hi-Flo A-Dimension=15.48"	230	1.5	520.00
*3420820-10	2" x 2" Hi-Flo A-Dimension=16.0"	230	2.0	610.00
*3421221-10	2" x 2" Hi-Flo A-Dimension=16.0"	230	3.0	730.00
3421621-10	2" x 2" Hi-Flo A-Dimension=16.98"	230	4.0	820.00

* = In-Stock Items

Waterway Spa Pumps Cont.

Circulation Pumps

FEATURES:

- 24-hour circulation
- 48-frame proven design
- Side discharge for optimum flow
- Multiple union assemblies available
- Delivers 40 GPM
- 1/8 HP
- Only 1.3 Amps
- Viton seals
- 1 1/2" Intake and Discharge
- One year warranty

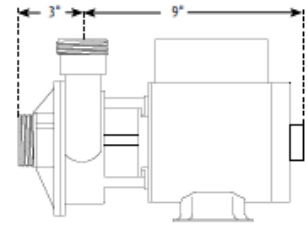
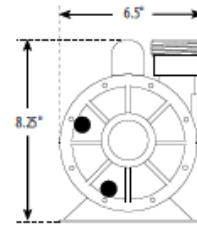

Single Speed Iron Might Circulation Pumps – 48 Frame

Part No.	Description	Volts	H.P.	Price
3410020-1E	1.5" x 1.5" Iron Might	230	1/8	420.00
3410030-1E	1.5" x 1.5" Iron Might	115	1/8	420.00

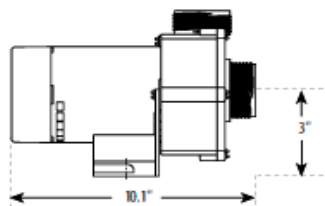
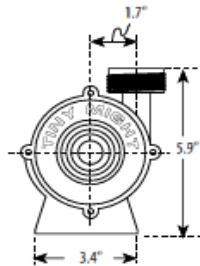

FEATURES:

- High volume side discharge efficiency
- 60% more efficient than our center discharge pumps
- Side discharge for optimum flow
- 1" union or 1" barb
- Wet end can be rotated for easy installation
- 1/16 HP
- Large 6 1/2" diameter wet end for higher head pressure
- One year warranty

Tiny Might Circulation Pumps

Part No.	Description	Volts	H.P.	Price
3312610-14	1" Union x 1" Union	115	1/16	380.00
3312620-14	1" Union x 1" Union	230	1/16	380.00
3312610-19	1" Barb x 1" Barb	115	1/16	380.00
3312620-19	1" Barb x 1" Barb	230	1/16	380.00

PoolCo USA

Waterway Spa Pump Wet Ends

Spa Flo Wet Ends

Part No.	Description	Quantity Per Case	Price
310-0700	1 HP Wet End	--	146.00
310-0800	1.5 HP Wet End	15	146.00
310-0810	2 HP Wet Wnd	15	146.00



310-0700



310-2360

EX2 Wet Ends

310-2450	48-Frame / 1.5 HP	161.00
310-2460	48-Frame / 2.0 HP	161.00
310-2480	48-Frame / 3.0 HP	161.00

EX2 Wet Ends

Part No.	Description	Price
310-2360	56-Frame / 1.5 HP	161.00
310-2370	56-Frame / 2.0 HP	161.00
310-2380	56-Frame / 3.0 HP	161.00
310-2390	56-Frame / 2.5 HP	161.00

2" Executive Wet Ends

Part No.	Description	Price
310-1870	48-Frame / 1.0 HP	161.00
310-1880	48-Frame / 1.5 HP	161.00
310-1890	48-Frame / 2.0 HP	161.00
310-1900	48-Frame / 3.0 HP	161.00
310-1910	48-Frame / 4.0 HP	161.00
310-1920	48-Frame / 4.5 HP	161.00
310-1930	48-Frame / 5.0 HP	161.00

2" Executive Wet Ends

Part No.	Description	Price
310-1710	56-Frame / 1.0 HP	161.00
310-1720	56-Frame / 2.0 HP	161.00
310-1730	56-Frame / 3.0 HP	161.00
310-1740	56-Frame / 4.0 HP	161.00
310-1750	56-Frame / 5.0 HP	161.00



310-1870

310-1870

2.5" Executive Wet Ends

Part No.	Description	Price
310-1800	48-Frame / 1.0 HP	161.00
310-1810	48-Frame / 1.5 HP	161.00
310-1820	48-Frame / 2.0 HP	161.00
310-1840	48-Frame / 3.0 HP	161.00
310-1860	48-Frame / 4.0 HP	161.00
310-1850	48-Frame / 4.5 HP	161.00
310-1830	48-Frame / 5.0 HP	161.00

2.5" Executive Wet Ends

Part No.	Description	Price
310-1460	56-Frame / 1.0 HP	161.00
310-1480	56-Frame / 2.0 HP	161.00
310-1500	56-Frame / 3.0 HP	161.00
310-1440	56-Frame / 4.0 HP	161.00
310-1510	56-Frame / 5.0 HP	161.00



310-1800

2" Hi-Flo Side Discharge Wet Ends

Part No.	Description	Price
310-1130SD	1.0 HP	155.00
310-1140SD	1.5 HP	155.00
310-1141SD	2.0 HP	155.00
310-1150SD	3.0 HP	155.00
310-1160SD	4.0 HP	155.00

1.5" Center Discharge Wet Ends

Part No.	Description	Price
310-1120	¾ HP	155.00
310-1130	1.0 HP	155.00
310-1140	1.5 HP	155.00
310-1141	2.0 HP	155.00



310-1130SD



310-1120



****Most Wet Ends Are In Stock – Check For Availability***

PoolCo USA

SUBMERSIBLE PUMPS



"Your Solution Innovator"

Includes garden hose adapter and removable inlet screen for easy cleaning. Lifetime oil supply. Pumps down to 1/8" (3.2 mm.).

Fluid Systems Design Parameters

- Motor - 1/6HP Shaded Pole
 flow rate - 1200 GPH @ 1', 4542 LPH @ 30 cm.
 Head - 26.3'...8 m
 t Liquid Temp to - 120° F...49° C
 - 1"FNPT (25.4 mm)
 Epoxy coated cast aluminum
 /lon
 Nylon
 - Viton®
 inless Steel
 - Manual
- Electrical - 115V, 60Hz, 5 amps, 25' (7.6m) power cord

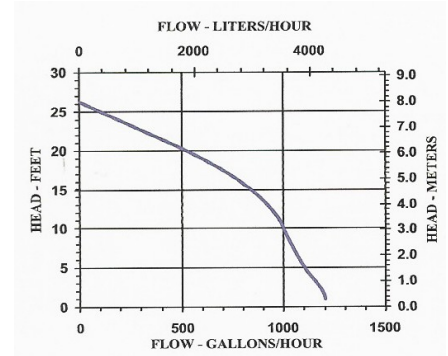

Little Giant® Automatic Pool Cover Pumps		
Item No.	Description	Price
APCP1700	Pool Cover Pump 1/3HP	310.00

APCP-1700 Series Features:

Activates in Approximately 2" of water
 3/4" MNPT Garden Hose adapter
 Maximum Flow of 1700 GPH @ 1"
 Unique Design for needed stability
 Mechanical float for dependability
 Cord length of 25'



Superior Submersible Utility Pumps – while supplies last										
Model No.	HP	Gallons per minute at discharge height in feet						Min. Lift	Min. Amps	Price
		0'	5'	10'	15'	20'	25'			
SP91014	1/4	28	23	16	12	8	1	25'	3.6	150.00
*SP91330	1/3	40	34	28	22	12	2	25'	4.1	220.00

*1/3 HP not stocked

- 1/5 & 1/3 HP motors, 120 v, 60 Hz
- Corrosion resistant construction.
- 8' waterproof power cord.
- Clog resistant open type impeller.
- Capacities of 26 & 40 gpm.



91025 & 91330

1/-11

PoolCo USA

Superior Specifications:



PoolCo USA

Air blowers and Vacuums

High Performance Air Blowers

Part No.	Description	Price
6318120	Silencer- 2Hp. 120v 9.0 amps,	335.00
3218120	Comet 2000/Ultra 9000 - 2Hp. 120v 9.0 amps,	230.00
4128100	Cyclone- 3Hp! 120v 3stage! 14.0 amps	800.00
HB-429-12	Duralast- 2Hp. 240v Single Phase	2,395.00
3018120	Replacement motor- 2Hp. 120v 9 amps,	180.00
3018220	Replacement motor- 2Hp. 240v 4.5 amps,	180.00



New Model Cyclone

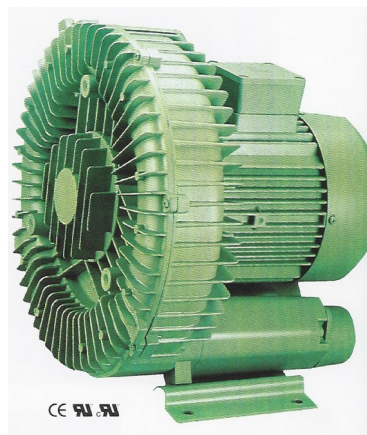
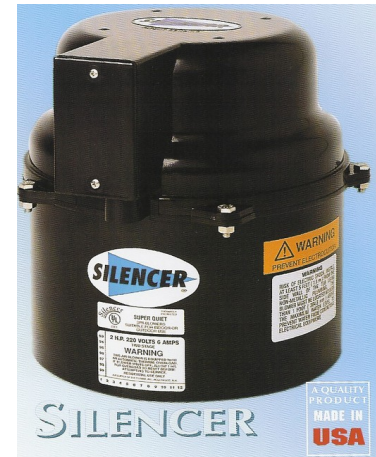

Liner Vacuums

Part No.	Description	Price
QV-3	NEW STYLE Q-Vac- with suction hose (picture next upper right)	1020.00
QF-60	60" Replacement flex suction hose for In-ground	200.00
GL20	GLI HD Deluxe blue liner vac w/ hose kit (blue - limited supply)	1,300.00
3027530	Cyclone- 3Hp! 120v 3stage! 14.0 amps Ideal Winterizer Blower	800.00