

Construction Supplies

Product No.	Description	Price
Vermiculite-Premium South African Grade with Easy Trowel Additives - Pickup C & C Prices only		
PX55	A-Tops Pre-mix- 2 Cubic Ft.- 55 Bags per skid - regular or pump mix	Call
P42	Palmetto Pre-mix - 2 Cubic Ft.- 45 Bags per skid - regular or pump mix	46.00
Due to market instability and demand please call for availability and current market costs		
Approximate Coverage Chart for In-ground Pools		
Size	A-Tops / Palmetto	Regular
16 x 32	60 52	30
18 x 36	80 70	40
20 x 40	100 85	50
<p>These figures are approximate and based on 2" thickness. Our experience demonstrates that you may get by with less. The amount of vermiculite may vary with the amount of water, mixing time, accuracy of excavation and troweling practice. Be sure to fill dips and low areas with other material so mix is not unnecessarily wasted.</p>		
Flex Piping		
PF50	½" PVC Flex Pipe – 100 ft. Roll	200.00
PF75	¾" PVC Flex Pipe - 100 ft. Roll	220.00
PF10	1" PVC Flex Pipe - 100 ft. Roll	260.00
PF15	1 ½" PVC Flex Pipe - 50 ft. Roll	174.00
PF15-100	1 ½" PVC Flex Pipe - 100 ft. Roll	340.00
PVC15	1 ½" PVC Rigid - 10' Piece	20.00
PF20	2" PVC Flex pipe - 50 ft. Roll	234.00
PF20	2" PVC Flex pipe - 100 ft. Roll	460.00
Sealants & Adhesives & Misc.		
BSA	Spray Tack Glue - For foam installation	30.00
Blue72	3-M Premium Spray Tack Glue- For foam installation (if available)	38.00
0530318	Epoxy Putty Sticks 2-part 7oz.	26.00
0530339	2-part Epoxy Pool Paste	22.00
BB260	Teflon Tape - ½" x 520"	1.00
DT60P	Premium Duct Tape – Natural Rubber for vinyl pools, 2" x 60 yds.	16.00
828	Premium all Stainless Steel Clamps – fits 1 ½" & 2" pipe	1.60
828-10	Premium all Stainless Steel Clamps – fits 1 ½" & 2" pipe (10-box price)	Each - 1.40
CL50DB	Copper lay-in ground lug w/SS screw	7.00
PB-SB	Copper split nut for # 8 bare	6.00
Wall Foam		
WF125-2	2lb. Wall Foam - 1/8" x 42" x 125' - Standard	150.00
WF125-3	3lb. Wall Foam - 1/8" x 42" x 125' - Standard Limited Supply	178.00
Pool Cove		
PC4	Pool Cove - Peel N' Stick	12.00
PC4-48	Pool Cove Case- Peel N' Stick, 48 pieces	560.00

Pool Cove Chart

	Qty. Required	Pool Size	Qty. Required
15' Round	12	30' Round	25
18' Round	15	15' x 30' Oval	18
21' Round	17	16' x 32' Oval	20
24' Round	19	18' x 33' Oval	22
27' Round	22	18' x 36' Oval	24



PoolCo uSA

PoolCo USA

MORTEX

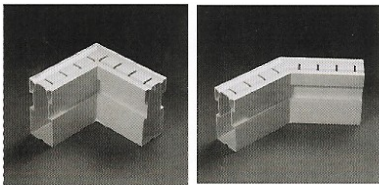

90° Angle

45° Angle

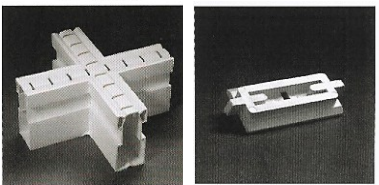

Cross

Clean Out Cover

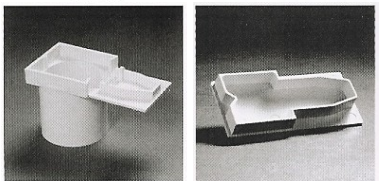

Down Spout

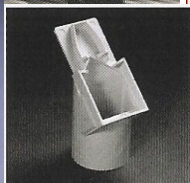
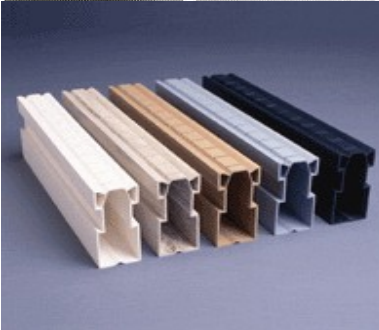

End Spout

Channel Rite (2 piece)

Part No.	Description	Price
CRW	Channel Rite – White 80' Cases	830.00
CRG	Channel Rite – Grey 80' Cases	830.00
CRX90W	Channel Rite – White 90 Degree	37.00
CRX45W	Channel Rite – White 45 Degree	37.00
CRX90G	Channel Rite – Grey 90 Degree	37.00
CRX45G	Channel Rite – Grey 45 Degree	37.00
CR-1	Channel Rite – 10' Section Each	105.00

Control Joints

CJW	Control Joint - White- 396' Box	345.00
CJRTW	Control Joint Replacement Top-White200'	150.00
CXC96SLT	Fill-N-Flex Tan Self Leveling joint Seal	190.00

Drain Rite

DRW	Drain Rite- White- 80' Case	740.00
DRG	Drain Rite- Gray- 80' Case	740.00
DRT	Drain Rite- Tan- 80' Case	740.00
DRC	Drain Rite- Charcoal- 80' Case	740.00
DX90W	90 Degree Angle- White	26.00
DX45W	45 Degree Angle- White	26.00
DXXW	Cross- White	44.00
DXTW	Tee- White	40.00
DXCOCW	Clean Out Cover- White	4.00
DXDS	Down Spout- White	16.00
DXSSW	Straight Spout- White	16.00
DXECW	End Cap- White	5.00
DXESW	End Spout- White	16.00
DXRTW	Drain Rite Replacement Top- White- 80'	420.00
DXRTG	Drain Rite Replacement Top- Gray- 80'	440.00
DRW-1	Drain Rite- 10' Section Drain- Each	93.00
DRW-1	Drain Rite- 10' Color Section Drain- Each	93.00

Accessories

FKLAK	Aluminum Key-Lock Keystone forms+Key	1,200.00
FXARC	Aluminum 112 AWM Keylock Radius Cut	990.00
FXARKS	Aluminum Keylock Radius Cut - Per Foot	10.00
FFGK	Fiberglass Forms	560.00
FKF	Plastic Keystone Forms Only	536.00
FXRCR	Plastic Keylock Radius Cut Retainer-PerFt	6.00

PoolCo USA

Safety equipment & deck Accessories

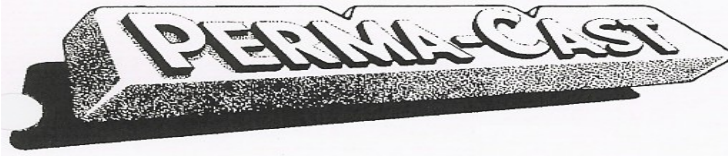

Part No.	Description	Price
Anchors:		
PS-4016-C	4" Brass Anchor (available also in 8" channel)	64.00
PS-4019-C	4" Aluminum Hanover Clone(Wedge #PW-4C)(for 1.9)	24.00
PC-4008-AC	8"Channel Set w/4" Aluminum Hanover Clone (for 1.9)	60.00
PC-4020-AC	20" Channel Set w/4" Alum. Hanover Clone (for 1.9")	65.00
07661	4" Glass filled PP (Plastic anchor f/salt water solutions)	22.00
PW-4C	4" Clone Wedge Assembly Replacement	12.00
PS-6019-B	6" Brass Stanchion Socket For VB & BB w/cap	86.00
JH	Johnny Hinge	450.00
Pool Bond:		
PB-2008	Cast Bronze International Electrical Bond	49.00
Escutcheon:		
PE-0019-C	Chrome Plated Cyclac	9.00
PE-0019-W or G	White or Grey Cyclac	6.00
PE-0019S	Stainless Steel Round (tall steel available spec. request)	12.00
25572-202	Split Clip-on Rail - Chrome Plated	20.00
25572-200	Split Clip-on Rail - White	14.00
Perma- Flange:		
PF-3119	Aluminum White Slide Flange	36.00
PF25	Cyclac Slide Flange	30.00
PF25-A	Cyclac Slide Flange with mounting hardware	38.00
8700	White ABS Plastic Ladder Flange A/G	8.00
Perma- Hook: Chrome Plated Brass		
PH-51H	Loop Hook (3/4 inch) (special order only)	39.00
PH-53	Cleat Type Hook (3/4 inch)	24.00
PH-55	S Hook (Chrome Plated Brass)	9.00
Removable Eye for Vinyl Liners		
PI-70	Oval Rope Eye	29.00
PI-74S	Rope Eye with Lag Shield Drill Concrete 3/4 inch	29.00
PI-2000	Female Receptor	32.00
PI-2000	Removable Eye for Vinyl Liners	35.00
PI-74S	Special Rope Eyes with Lag Shield	33.00



PE-0019-W White Cyclac
PE-0019-C Chrome Cyclac

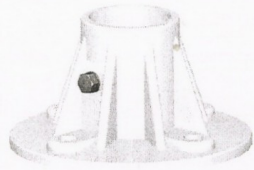

Cyclac Plastic Slide Flange
PS-25, PF-25-A w/hardware



Cleat Type Hooks
PH-52, PH-53



S-Hooks
PH-55, PH-56

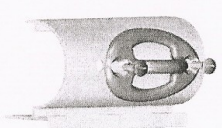

PI-70
Oval Rope Eye



Rope Eye with Lag Shield
PI-74S
Drill Concrete 3/4 inch

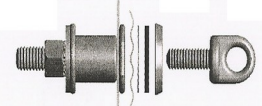

PI-2000
Female Receptor

PoolCo USA

Salt System Corrosion Prevention



Part No.	Description	Price
Technodes: Swimming Pool Anodes & Bonding		
TN-LD	Ladder Anode – Sold in Pairs	50.00/pair
TN-LT	Light Anode	34.00
TN-IL20	Inline Anode – 2” NEW Large Heavy Duty	170.00
TN-100	Inline Replacement Zinc For TN-IL – 1 ½” & 2”	64.00
TN-SK	Utility Anode/Skimmer Weight	26.00



TN-LAD LADDER TECHNODE

- SACRIFICIAL ZINC ANODE
- HIGH SURFACE TO VOLUME RATIO
- FITS ALL 1.9 INCH LADDER RAILS
- COMPACT DESIGN WILL NOT INTERFERE WITH SWIMMERS



INLINE TECHNODE

- ANODE CONNECTS DIRECTLY TO METAL FILTER OR HEATER CORE
- CLEAR PVC CONSTRUCTION FOR EASY ANODE INSPECTION
- SIMPLE ANODE REPLACEMENT



TN-LT LIGHT TECHNODE

- SACRIFICIAL ZINC ANODE
- HIGH SURFACE TO VOLUME RATIO
- PROTECTS DECORATIVE LIGHT RING & METAL NICHE FROM SALT CORROSION
- DEVELOPED BY SCIENTISTS AT GEORGIA TECH



UTILITY TECHNODE

- SACRIFICIAL ZINC ANODE
- HIGH SURFACE TO VOLUME RATIO
- ATTACHES EASILY TO SKIMMER BASKET

What is a Sacrificial Anode? A sacrificial metal anode is used to protect critical metal components in a salt system swimming pool. The sacrificial anode is connected electrically (either through direct contact or by use of a wire) to the metal to be protected. In a salt system pool, for example, a pool heater core will normally tend to corrode as a result of being in contact with the pool water. If this heater core is connected to a properly designed sacrificial anode, the anode will tend to corrode and transfer electrons to the heater core. At the interface between the pool water and heater core these electrons will create a chemical reaction that protects the heater core. The heater core (**cathode**) attracts electrons produced by the corroding sacrificial anode. The electrons react at the surface of the heater core with elements in the water. This reaction protects the heater core at the expense of the **sacrificial anode**. This transfer of electrons from the sacrificial anode to the metal to be protected is referred to as **Cathodic protection**. Cathodic Protection is illustrated to the right.

Examples of Sacrificial Anodes: All water heaters utilize sacrificial anodes to protect their steel tanks from corroding. The single most important factor in whether a water heater lives or dies is the condition of its sacrificial anode. Ships have anodes installed on their hulls to protect the steel hull from corroding in sea water. Lobster traps utilize sacrificial anodes to prevent corrosion on the ocean floor. Off shore oil rigs, buried pipelines, storage tanks, steel piers, and oil wells all utilize sacrificial anodes to prevent corrosion and premature failure of their critical components.

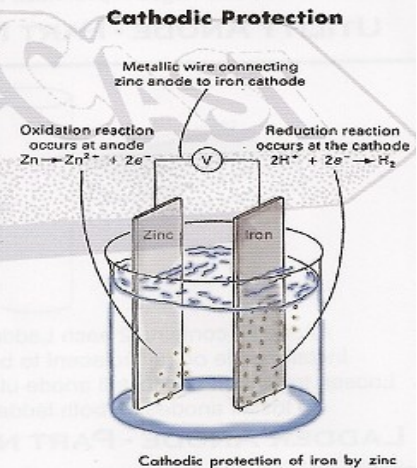

Why use TechNodes: TechNodes are the result of research done by Scientists at the Georgia Institute of Technology. TechNodes are sacrificial anodes designed specifically to protect critical metal components in Salt System Swimming Pools. TechNode In-line is designed to protect any metal components in the pools plumbing, including pool heaters and heat exchangers. TechNode Ladder will protect pool ladders that are submerged in the swimming pool. TechNode Light will prevent corrosion of metal components on underwater lights. TechNode Utility is designed to protect any other metal components in the swimming pool. TechNodes are cast from Mil Spec Zinc, have high surface area to volume characteristics resulting in the most efficient Pool Anodes on the market.

PoolCo USA

Safety Equipment - Continued

While supplies last

Aqua Sensor- Pool Alarms

Swim Alert- MSRP \$599.00	780.00
Espio- MSRP \$699.00	910.00



SUMMARY OF KEY FEATURES

- Exclusive Aquasensor fall detection technology
- ASTM F2208-02 Certified
- Magnetic keys for poolside activation/deactivation
- Strong poolside alarm- 100 db
- Strong indoor wireless remote alarm (85db) with 100' range
- Effective in pools up to 20' x 40' (1,000sqft)
- Automatic rearming after bathing
- All installation hardware included
- Alarm Failure signals
- Low battery light
- Batteries included (4 "D")
- Chemical and UV-resistant materials of construction
- Two-year limited warranty
- Poolside unit dimensions: 9.5" x 9" x 2.5"
 - UL listed
 - NSF certified

Other Safety Equipment availability

call for

55584	Throwline-60 ft.	30.00
55553	Pool Ring-19"	40.00
55554	Pool Rings-24"	50.00
55549	USCG Approved Ring Buoys- 19" white	160.00
55550	USCG Approved Ring Buoys- 24" white	200.00

Safety Turtle

B101	Base Station- AC adapter, & user guide (Eng. & Spanish)	139.00
T101G,B,R,Y,or P	Turtle Wristband- Baby turtle plug for base station, key for locking buckle, Comes in Green, Blue, Red, Yellow, or purple	69.00
P101	Turtle Power- Battery pack & waterproof carrying bag	119.00

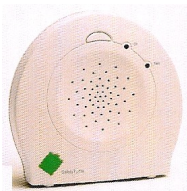



Rope Kits- 2-Hook Ropes

RFK16	16' Rope Kit	36.00
RFK18	18' Rope Kit	43.00
RFK20	20' Rope Kit	50.00
RFK22	22' Rope Kit	60.00
RFK25	25' Rope Kit	70.00
	Twist Lock Pool Floats- 3" x 5"	5.00

PoolCo USA

Deck Jets & Fountains

Deck Jets

Designed for residential pools, but with features only found on higher priced commercial water features. Eyeball is hidden from view by decorative cap. Four different cap colors are included with each deck jet. A variety of plumbing choices makes this deck jet easier to install. Only takes 3-5 GPM for a stream of water up to 10 feet high. Made for simple installation and trouble-free operation.



Deck Jets		
25597-000-000	Deck Jet Assembly	\$ 170.00

Features:

- Individually Packaged
- Includes body, adjustable nozzle and four colored, round decorative caps (white, black, gray, tan)

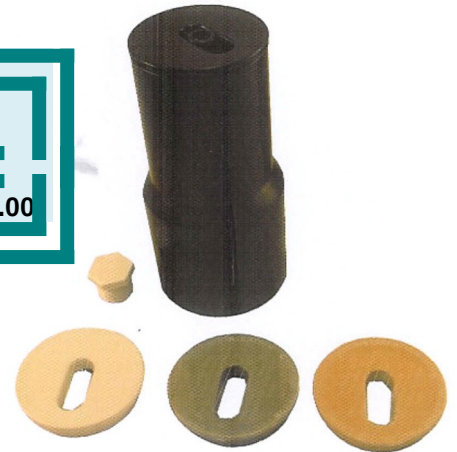

Deck Jet and Wall Jet Specifications

GPM	3 GPM	4 GPM	5 GPM
Feet of Head	3.9	7.9	11
Height of Water Stream	3 Ft	6.5 Ft	10 Ft

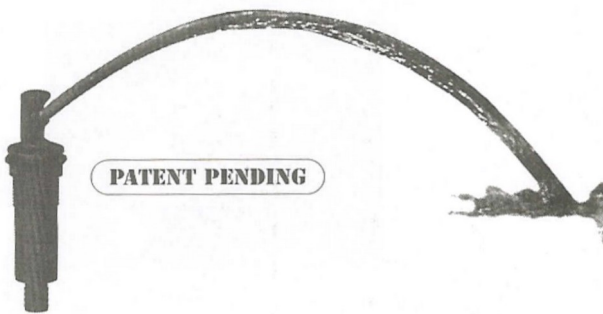

Pop-UP Deck Jets		
675-0700	3/4" Ribbed barb	N/A
675-0710	3/4" Smooth barb	"
675-0720	3/2" Socket	"

POP-UP WATER FEATURE

Features:

- Pops up when pressurized.
- Drops down when unpressurized.
- Solid 7/16" rod shaped water stream, projects at 45° angle
- Available in several body styles and colors.
- Max. flow 4.76 GPM @ 3 PSI = 48" cascade.

Fountains		
180005	Waterfall Fountain	22.00
180006	Flower Fountain	22.00
180010	Grecian Fountain	44.00
180015	Rock Fountain	46.00
8592	Swan Floating Fountain- Triple Tier	75.00
8590	25' Fountain Transparent replacement hose	10.00



180010

PoolCo USA

Hef-T-Pad

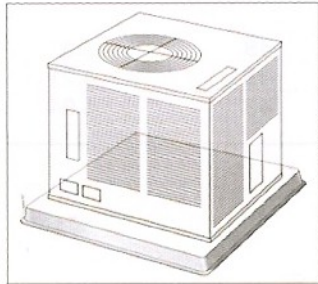

HEF-T-PAD™ Features:

- Injection molded from high impact polyolefin for strength and durability.
- Resistant to impact, UV degradation and weathering.
- Will not crack, flake or warp.
- Virtually impervious to climate changes.
- Drillable, permits installation of refrigerant and electrical lines under and through pad.
- Also permits equipment to be easily secured to pad.
- Unique, non-creep surface absorbs vibration and noise and keeps equipment in it's original position.
- Gray

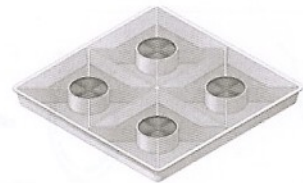

Underside of Hef-T-Pad showing support ribs, stabilization pads and stabilization flange.

Product No.	Description	Price
X2430211	24" x 30" x 2" Hef-T-Pads	38.00
X3232211	32" x 32" x 2" Hef-T-Pads	48.00
X3030311	30" x 30" x 3" Hef-T- Pads	46.00

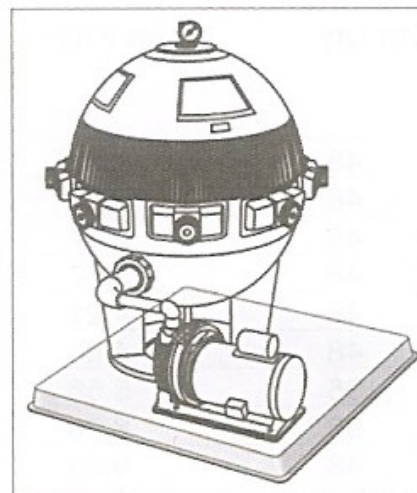
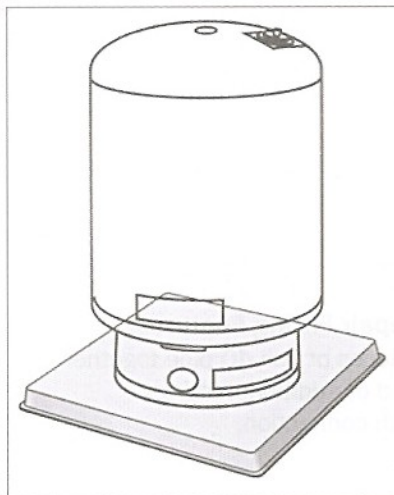

PoolCo uSA

PoolCo USA

Pool Paints



Item No.	Product
HBE311	High Build Epoxy Premium 2 Gallon Kit
HBE328	High Build Epoxy Premium 2 Gallon Kit
A2R311	Type A 2 Synthetic Rubber base 1 gallon
A2R328	Type A 2 Synthetic Rubber base 1 gallon
PSL-1	Special Nitrile Flex Rubber Caulking
AXTHG	Gallon Thinner

ALL PAINT PRODUCTS ABOVE ARE VOC COMPLIANT



This premium synthetic rubber coating is formulated to provide excellent hiding, coverage, and protection. It restores and upgrades previously painted chlorinated rubber and synthetic rubber surfaces.

- Superior coverage rate compared to other rubber-based paint
- High-gloss finish allows for easy cleaning
- Easy to apply by roller or airless sprayer
- Self-priming, two-coat system
- VOC compliant in US and Canada

HI BUILD EPOXY

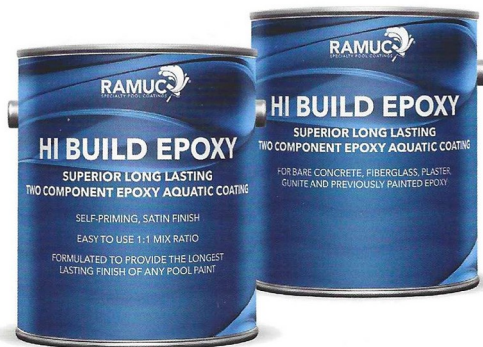

This superior high-build epoxy coating is formulated to provide the longest-lasting finish of any pool paint.

- Renovates aged concrete, plaster, and fiberglass/gelcoat surfaces
- Compatible with salt water systems
- Alternative to plastering at one-third the cost
- Abrasion and chemical-resistant
- Self-priming, two-coat system
- VOC compliant in US and Canada
- Available in both 1 & 2 gallon kits*

PoolCo USA

IPS CORPORATION
IPS

WELD-ON

The Leader in Innovative Products
for the Plastic Pipe Industry



700

Regular Bodied, fast setting, PVC Cement for all classes and schedules with interference fit through 4" diameter (except Schedule 80). This product may also be used on PVC foam core pipe.

CLEAR

3 Year Shelf Life
Meets ASTM D-2564



13552	740 PVC Medium Body Clear - Pint	24.00
-------	----------------------------------	-------

10078	700 PVC Medium Body Clear - Gallon - While supplies Last	180.00
-------	---	--------



725 Wet 'R Dry

Medium bodied, extremely fast setting, PVC cement for all classes and schedules with interference fit through 6" diameter, Schedule 80 through 4" diameter. Specially formulated for rigid and flexible applications where conditions are wet and/or when quick pressurization is desired. Can be used without primer on non-pressure systems if local codes permit.

AQUA BLUE

3 Year Shelf Life
Meets ASTM D-2564



10166	725 PVC Wet "R" Dry Aqua Blue - Pint	44.00
-------	--------------------------------------	-------



747 Pool 'R Spa

Medium bodied, extremely fast setting, PVC cement for all classes and schedules with interference fit through 6" diameter, Schedule 80 through 4" diameter. Developed for rigid & flexible applications, wet conditions and/or quick pressurization. Can be used without primer on non-pressure systems if local codes permit

BLUE (fades to CLEAR)

3 Year Shelf Life
Meets ASTM D-2564



10853	747 PVC Pool "R" Spa Blue - Pint	28.00
-------	----------------------------------	-------

10851	747 PVC Pool "R" Spa Blue - Gallon - While Supplies Last	160.00
-------	---	--------



PURPLE/CLEAR
3 Year Shelf Life

PC-64 Primer- Cleaner

For Cleaning and surface preparation of PVC and CPVC pipe fittings.

10873	PC-64 Primer-Cleaner Purple – Pint - While Suppies Last	24.00
10871	PC-64 Primer-Cleaner Purple – Gallon - While Suppies Last	90.00
10202	PC-65 Clear Cleaner - Pint	22.00



Glue-Mate

2000	Glue-Mate	18.00
14550	Easy – twist can opener	12.00